

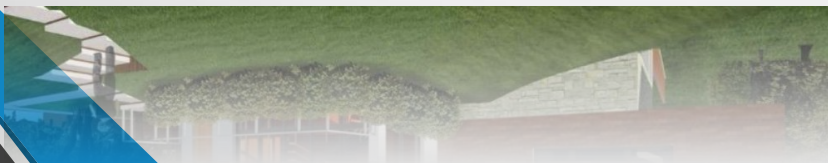

# Engineering Career Pathways

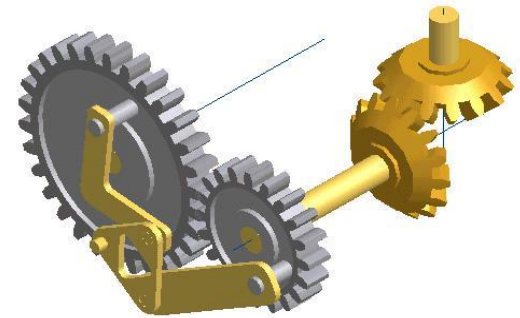



I am **Mr. Reilly**

I am the Engineering Career  
Pathway Chair Head, as well as the  
Architecture and Engineering  
Teacher

# Do you like:

**To Research?**      **Want To Have Fun?**

**To Create?**      **To Problem Solve?**

**Want To Have Fun?**

**To Build?**

**To Actively Work?**

**To Help Others?**

**To Design?**

**To Be Creative?**

**Be Hands –On?**

**Want To Have Fun?**

**Want To Have Fun?**

**To Develop?**



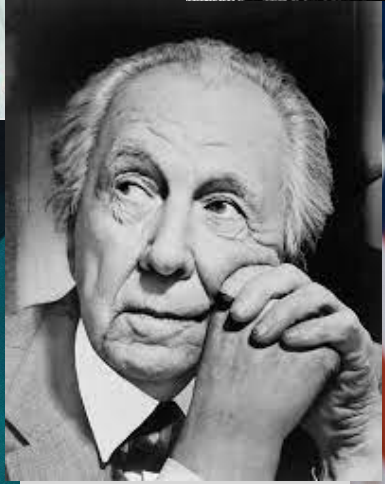
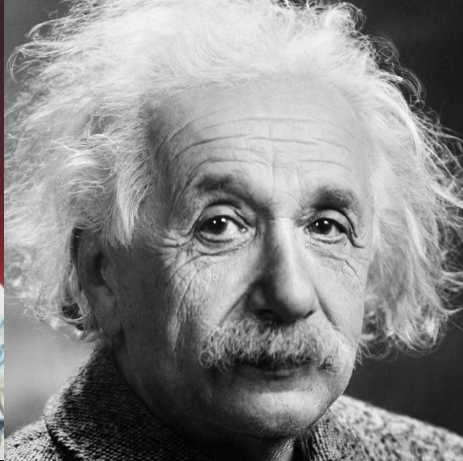





# Engineering Department

Mechanical

Architecture/Civil



Intro. to Engineering Design  
Engineering Design-Mechanical  
Engineering Design-Electrical  
Robotics I/II

Architectural Design I  
Architectural Design II

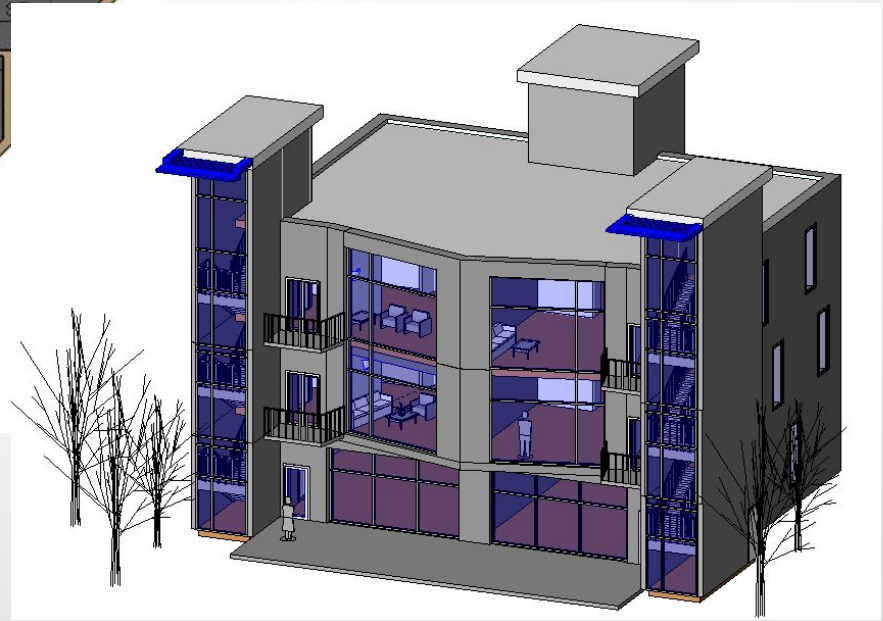

Residential Design

# Architectural Design I

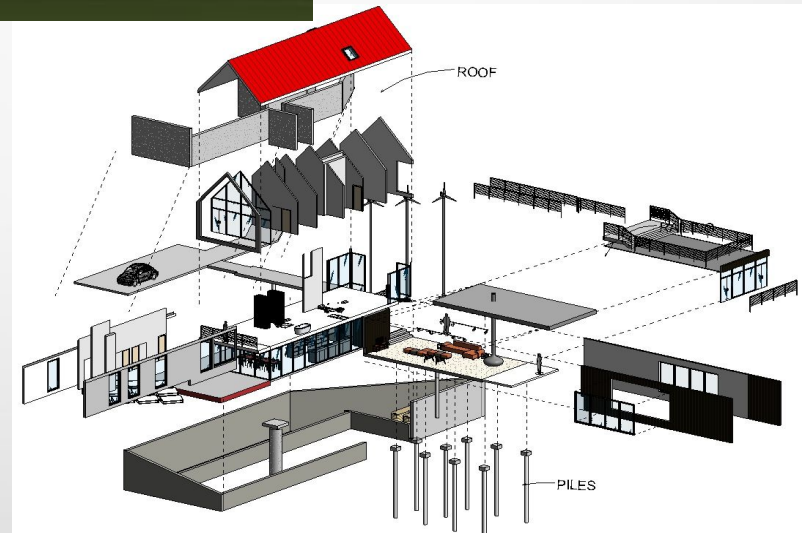

Residential Design

# Architectural Design I





Civil/Commercial

# Architectural Design II



# Architectural Design II













Outdoor Mall Creation

# Architectural Design I

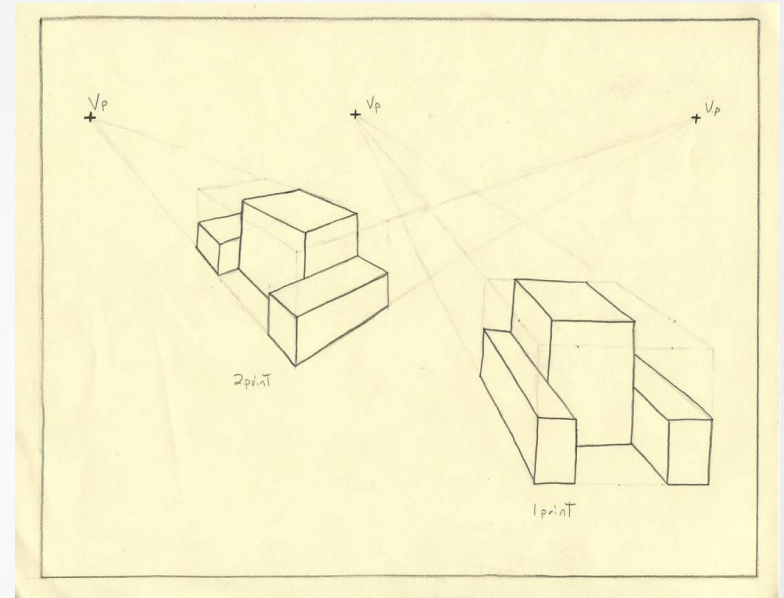
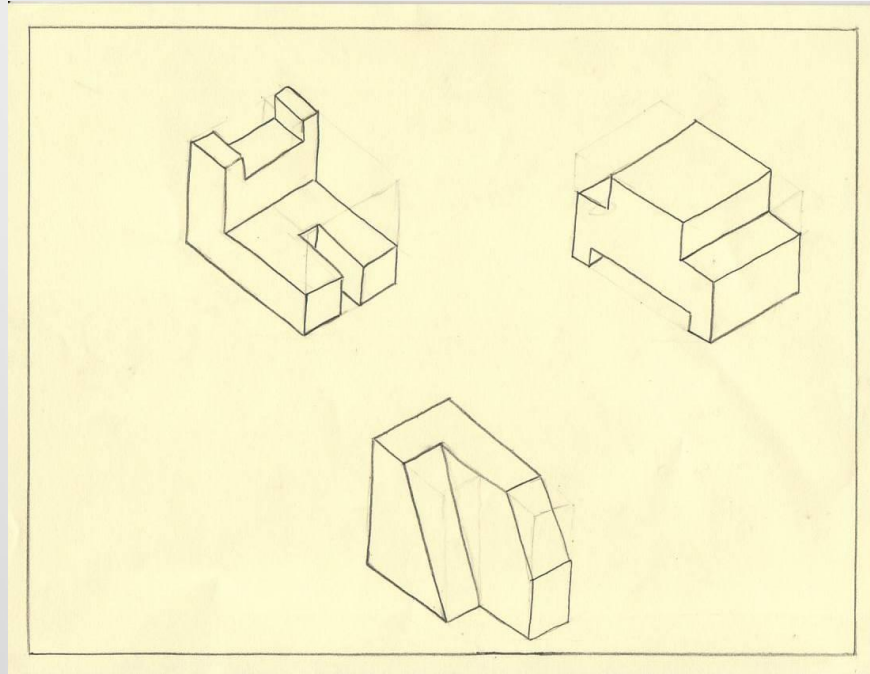

Technical Sketching

Intro. to Engineering Design

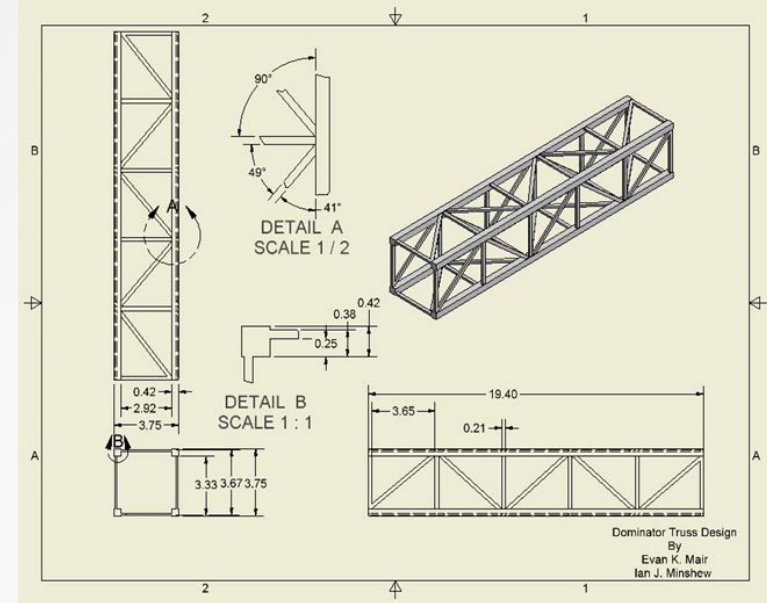
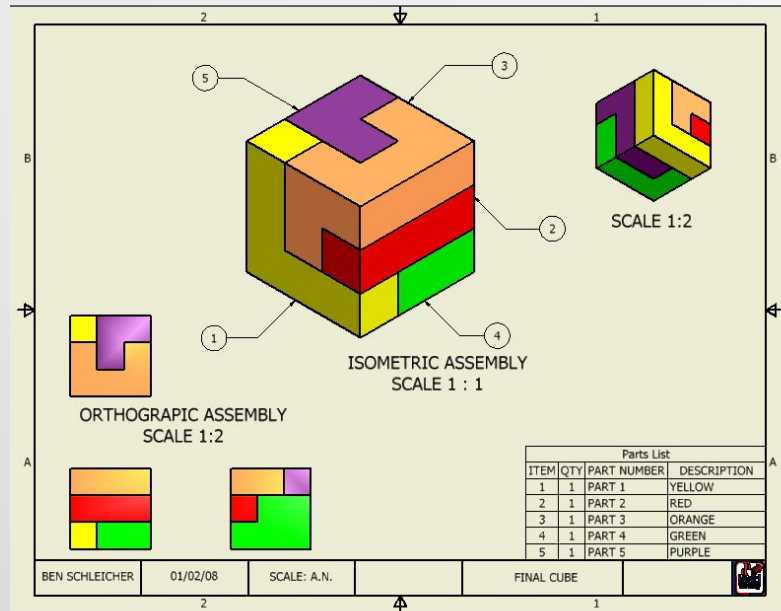

CAD Drawings

# Intro. to Engineering Design

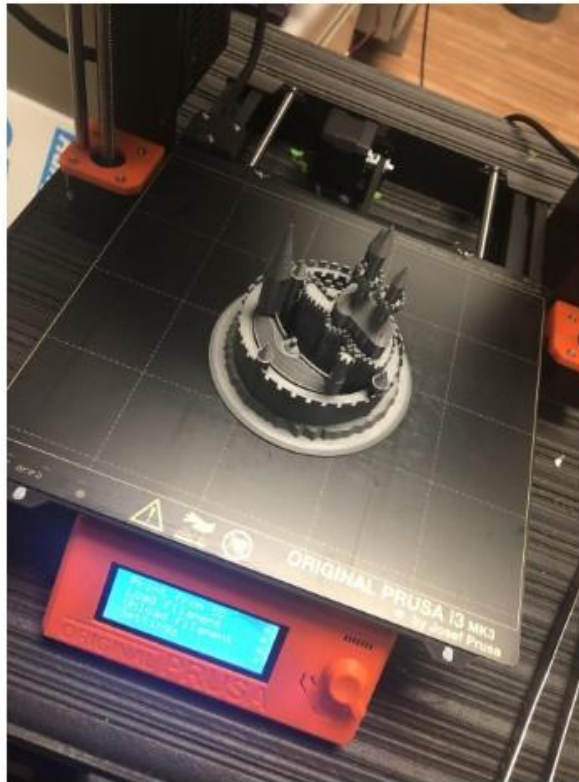

3D Design and Development

# Intro to Engineering



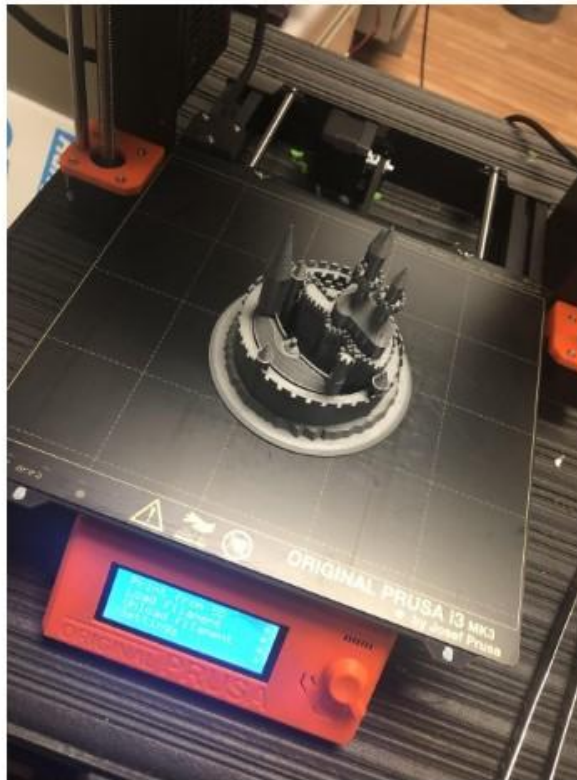

3D Design and Development

# Intro to Engineering

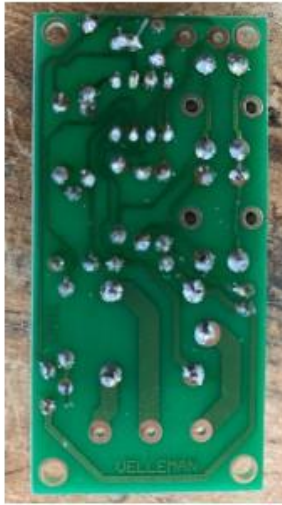

King of the Hill Problem  
Solving Activity

**Electrical Engineering**



Machine Work



Engineering Design- Mechanical



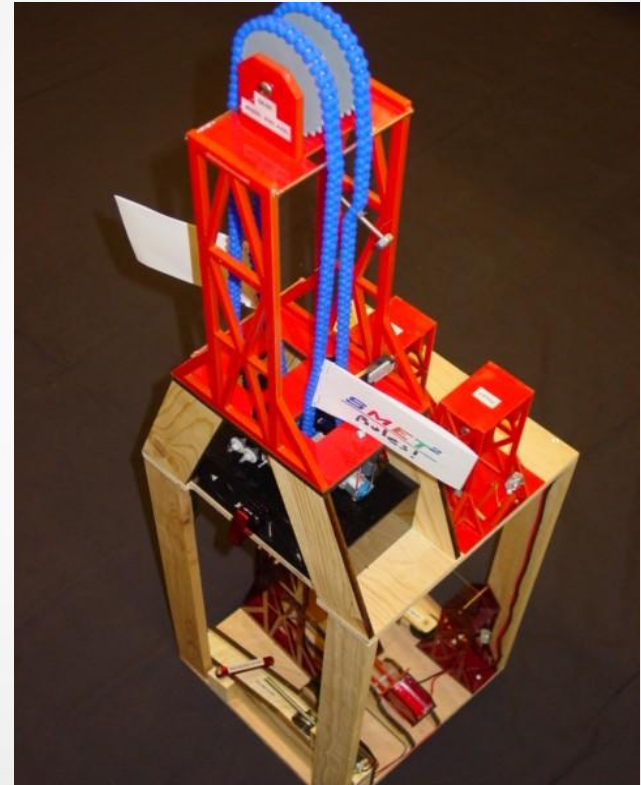
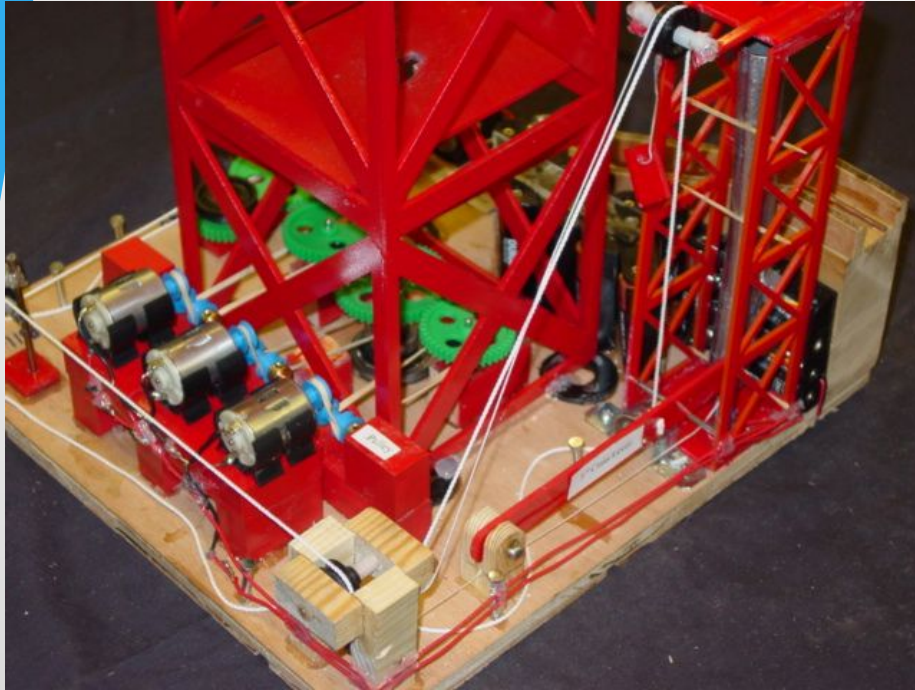

Rube Goldberg

Engineering Design- Mechanical



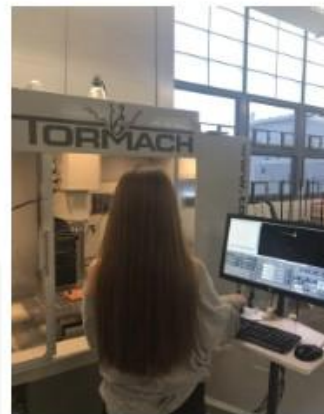

Machining

Engineering / Robotics



Are There Jobs Out There for Me?

Will I Make Enough Money to Live the Life I Want?

Will I Receive Job Satisfaction?

Will I Love My Job?

Palisades High School Engineering Career Pathway is here to do everything from introducing students to the architectural and engineering world to preparing them to pursuit an amazing and rewarding career.

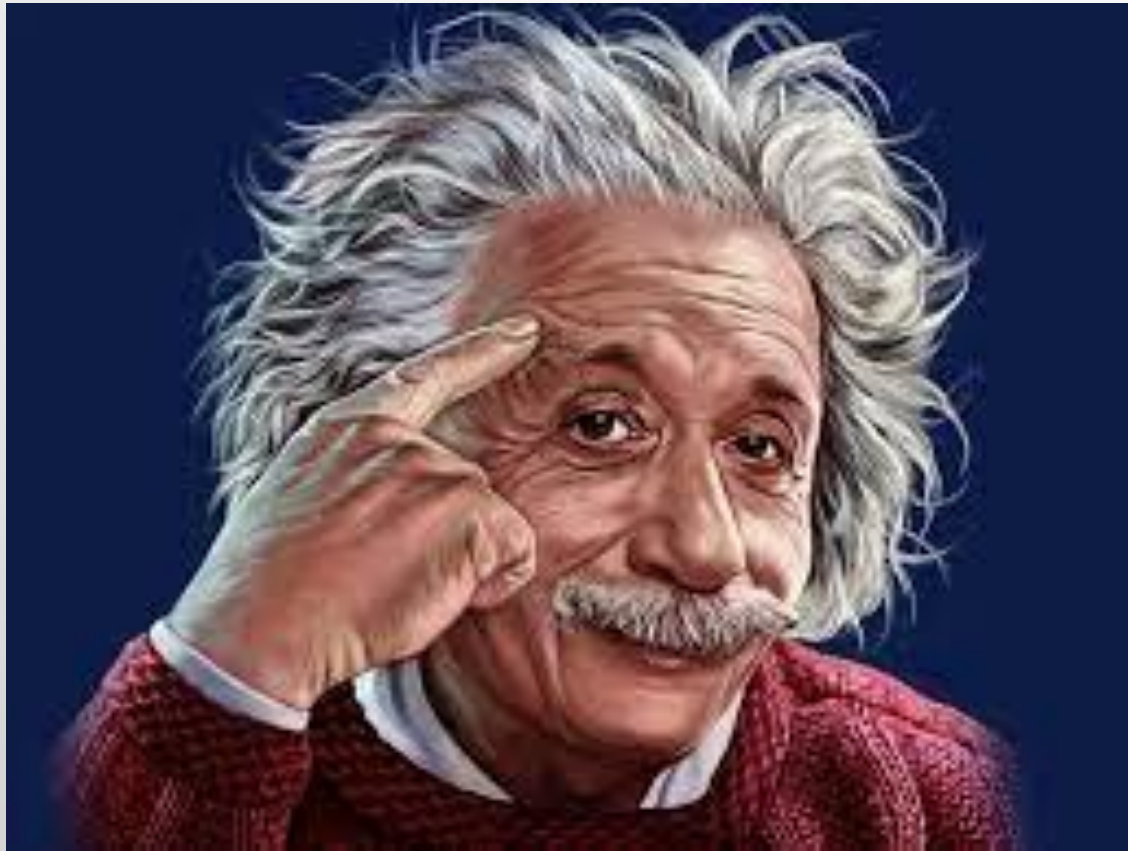



Any Questions?